

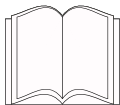

de Montageanleitung
en Installation instructions
fr Notice d'installation
nl Installatie-instructies
it Istruzioni d'installazione
el Οδηγίες εγκατάστασης
es Instrucciones de montaje
pt Instruções de instalação
sv Installationsanvisningar
no Installasjonsveiledning
fi Asennusohjeet
da Installationsvejledning
tr Kurulum talimatları
ru Инструкция по установке
cs Pokyny k instalaci
pl Instrukcje montażu
hu Telepítési útmutató
hr Upute za instalaciju
mk Упатства за инсталирање
sl Navodila za montažo

sr Uputstva za montažu
et Paigaldusjuhised
lt Įrengimo instrukcijos
lv Uzstādīšanas instrukcijas
sk Pokyny na inštaláciu
sq Udhëzimet e instalimit
fa دستورالعمل نصب
ar تعليمات التركيب
ko 설치 설명서
zh 安装说明
uk Інструкція з монтажу
ro Instrucțiuni de instalare
bg Инструкции за монтаж
ja 設置説明書
he הוראות התקנה
id Petunjuk pemasangan
kk Орнату нұсқаулықтар
zh-hk 安裝說明
zh-tw 安裝說明
uz O'rnatish bo'yicha yo'riqnomalar





de	über den Kundendienst erhältlich	sr	može se dobiti preko korisničkog servisa
en	Available from our after-sales service	et	saadaval hooldekeskuse kaudu
fr	disponible via le service après-vente	lt	galima įsigyti klientų aptarnavimo tarnyboje
nl	bij de servicedienst verkrijgbaar	lv	var saņemt klientu apkalpošanas dienestā
it	disponibile presso il servizio di assistenza clienti	sk	dostupné prostredníctvom zákazníckeho servisu
el	διαθέσιμο από την υπηρεσία εξυπηρέτησης πελατών	sq	marrja e mundshme përmes shërbimit të klientit
es	disponible a través del Servicio de Atención al Cliente	fa	در مرکز خدمات مشتریان موجود است
pt	pode ser adquirido nos nossos Serviços Técnicos	ar	يمكن الحصول عليها من خدمة العملاء
sv	går att beställa via service	ko	고객 서비스센터를 통해 구입 가능
no	fås hos kundeservice	zh	可向客户服务索取
fi	saatavissa huoltopalvelusta	uk	Через сервісну службу
da	Fås hos kundeservice	ro	se pot obține de la serviciul de asistență pentru clienți
tr	müşteri hizmetlerinden temin edilebilir	bg	предоставя се от службата за обслужване на клиенти
ru	можно приобрести через сервисную службу	ja	カスタマーサービスを通じて入手可能
cs	k dostání v zákaznickém servisu	he	זמין דרך שירות הלקוחות
pl	do nabycia w punkcie serwisowym	id	Tersedia di Layanan Pelanggan
hu	a vevőszolgáltatón keresztül kapható	kk	сервистік қызмет арқылы алуға болады
hr	može se kupiti kod servisne službe	zh-hk	可向售後服務站索取
mk	достапно преку сервисната служба	zh-tw	可向客戶服務單位索取
sl	na voljo prek pooblaščenega servisa	uz	otishdan keyingi xizmat orqali olish mumkin

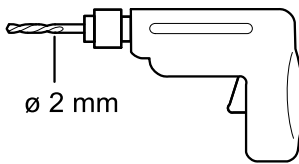
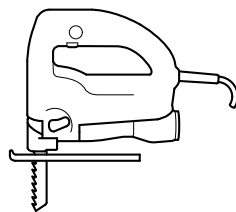
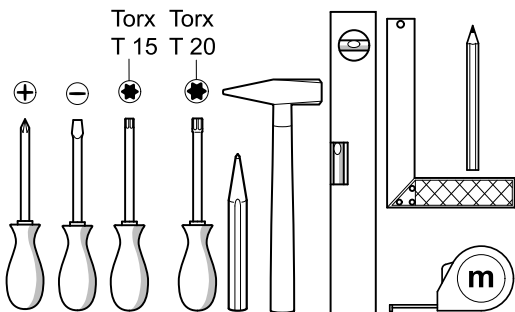
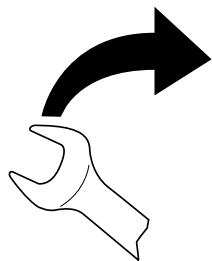
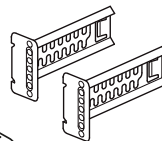
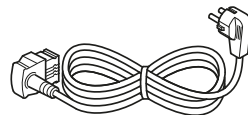
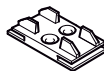
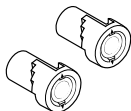
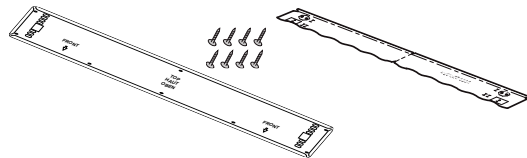
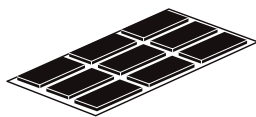
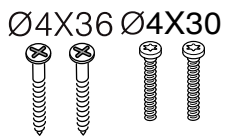
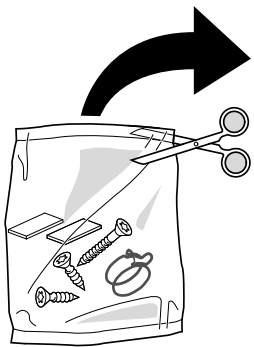

SW13

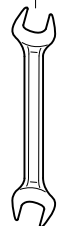

SW10

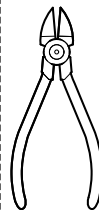

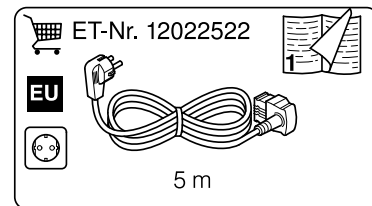
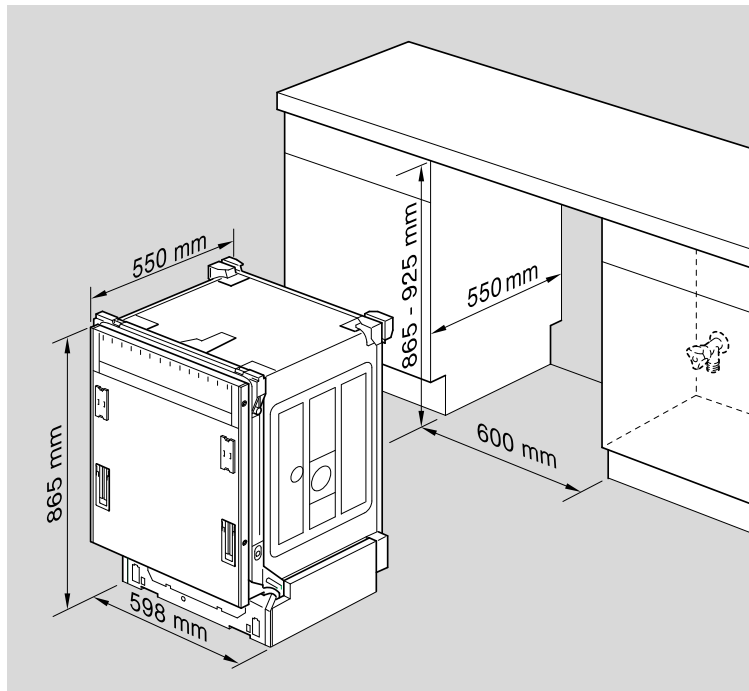
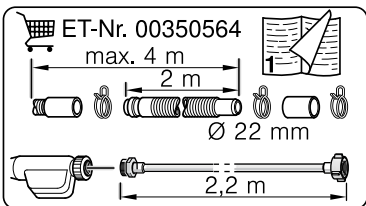
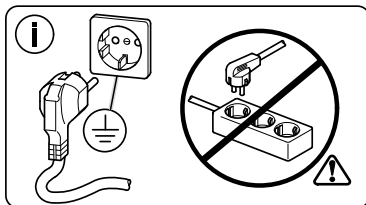
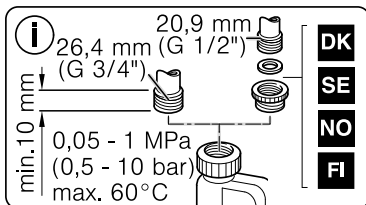
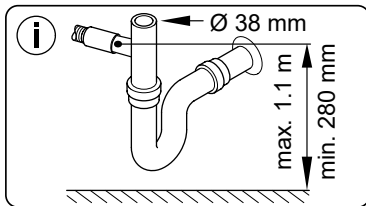

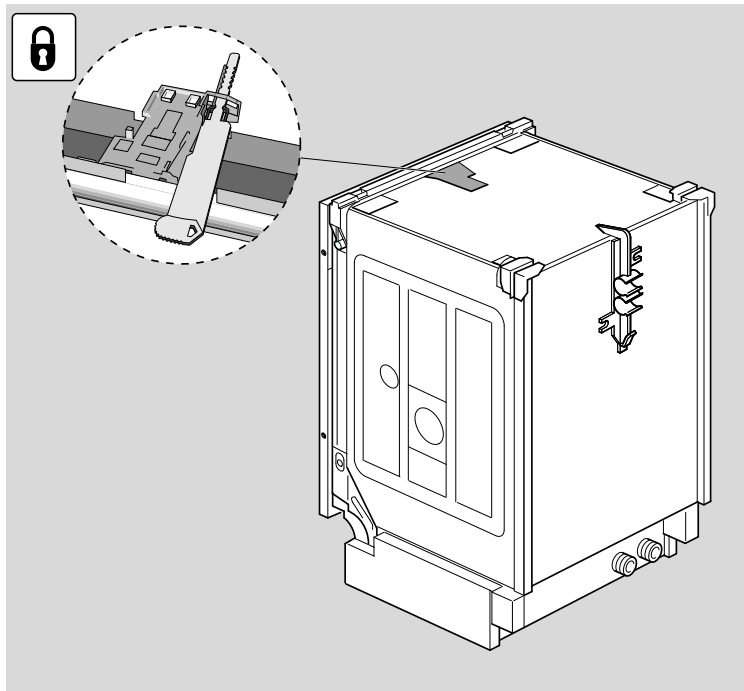
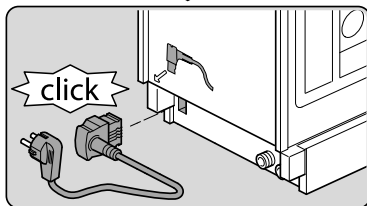
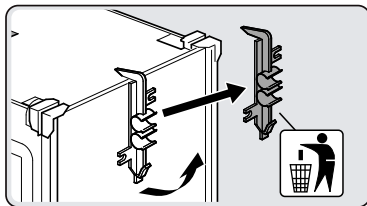

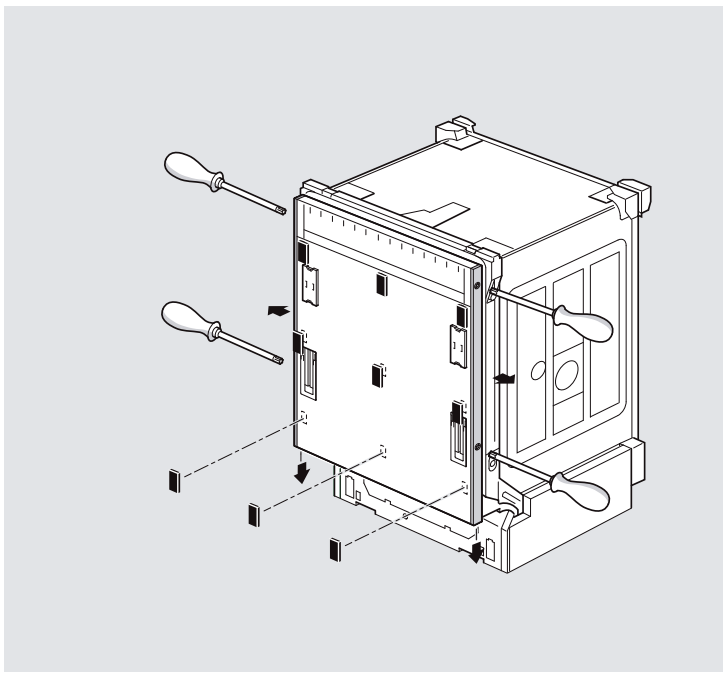
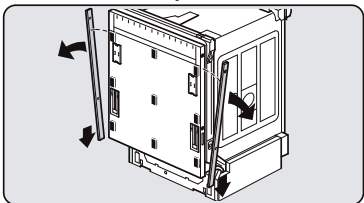
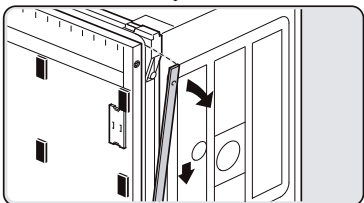
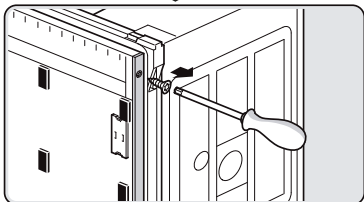
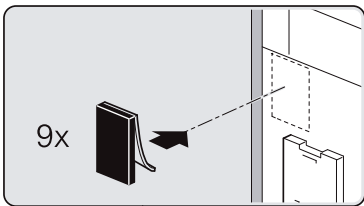
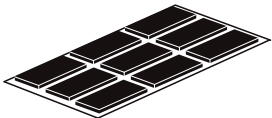

Torx
T 15



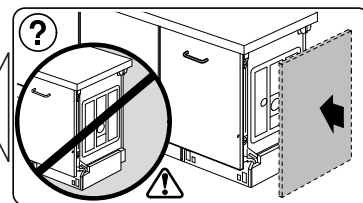
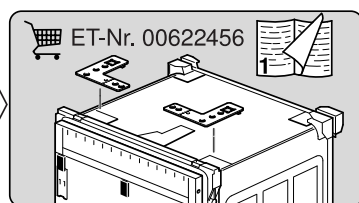
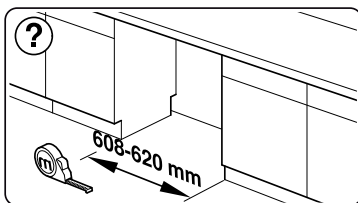
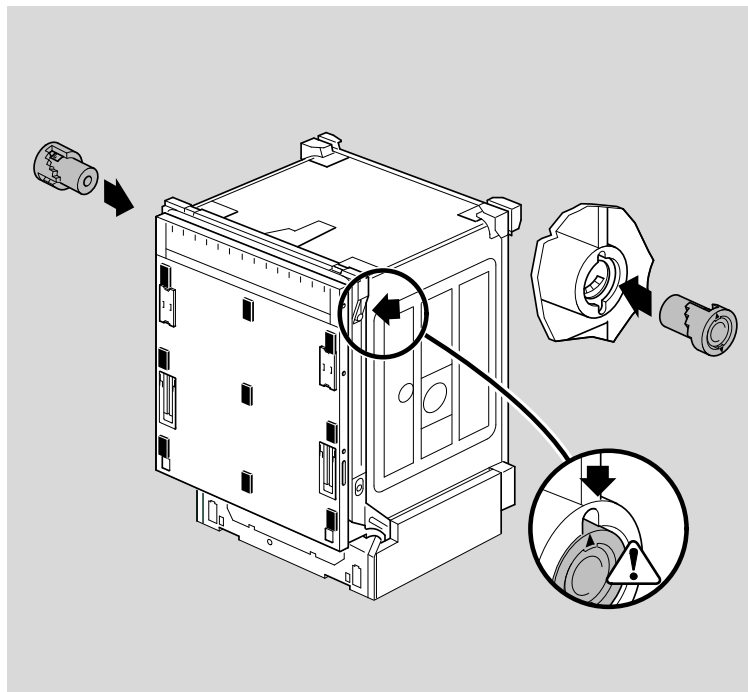
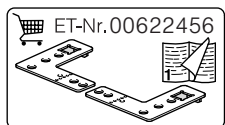
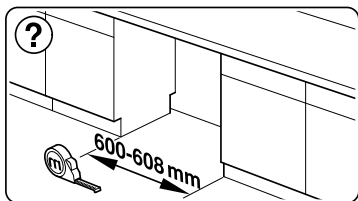

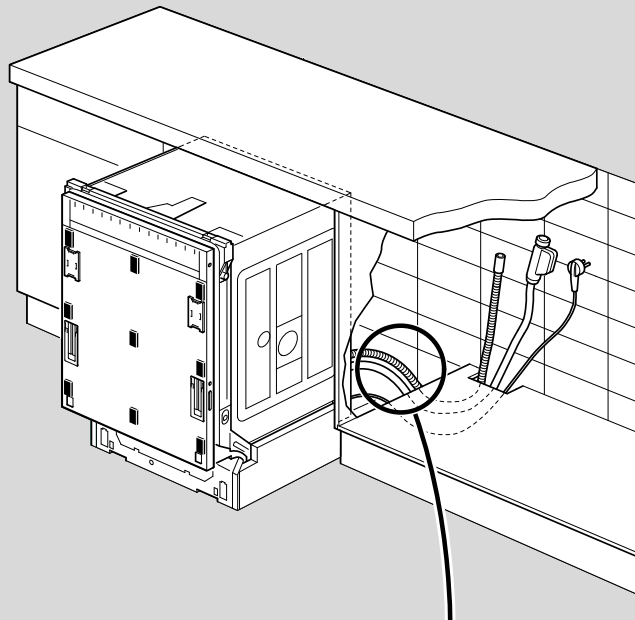
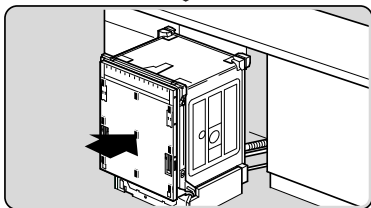
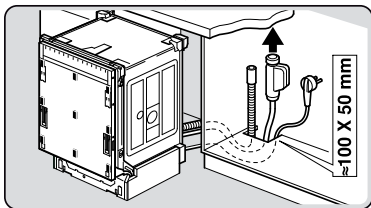
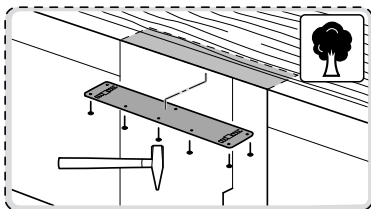
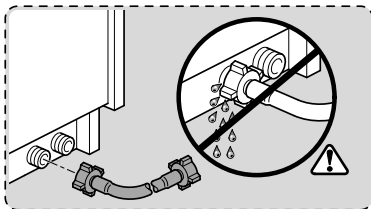
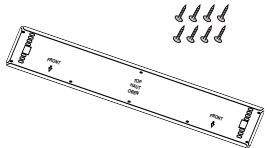

nicht einklemmen
do not pinch
ne pas coincer
No doblar

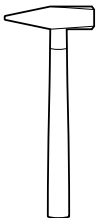
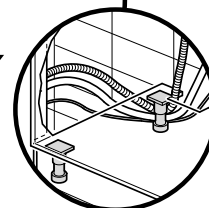

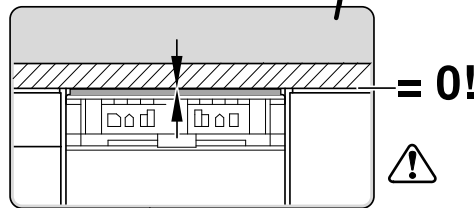
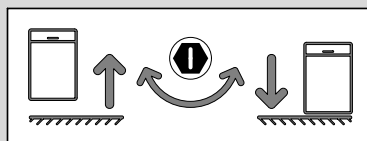
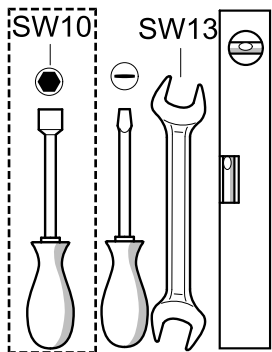
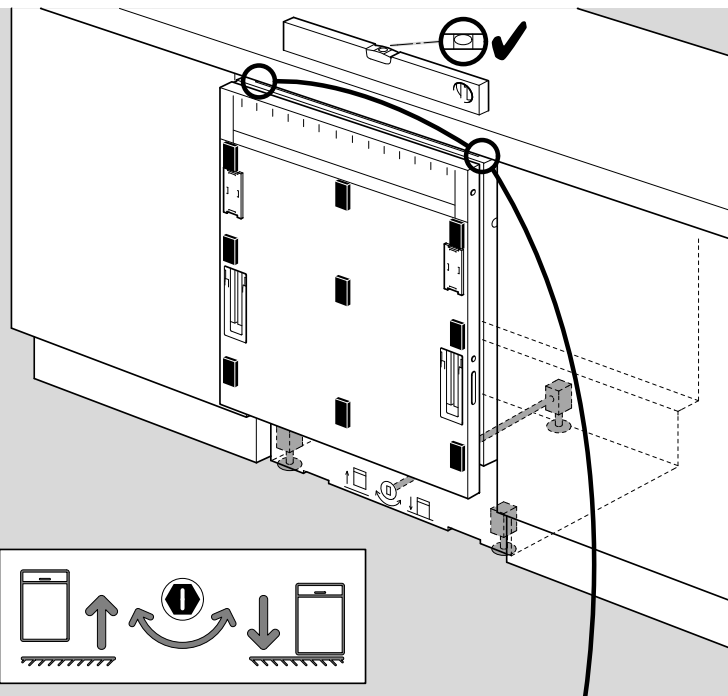
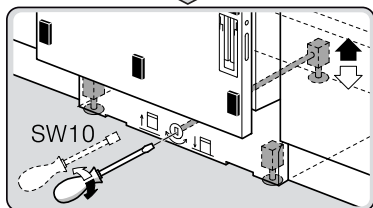

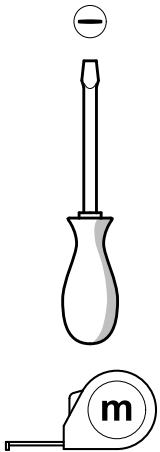
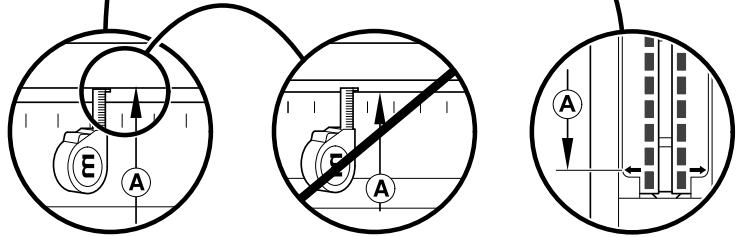
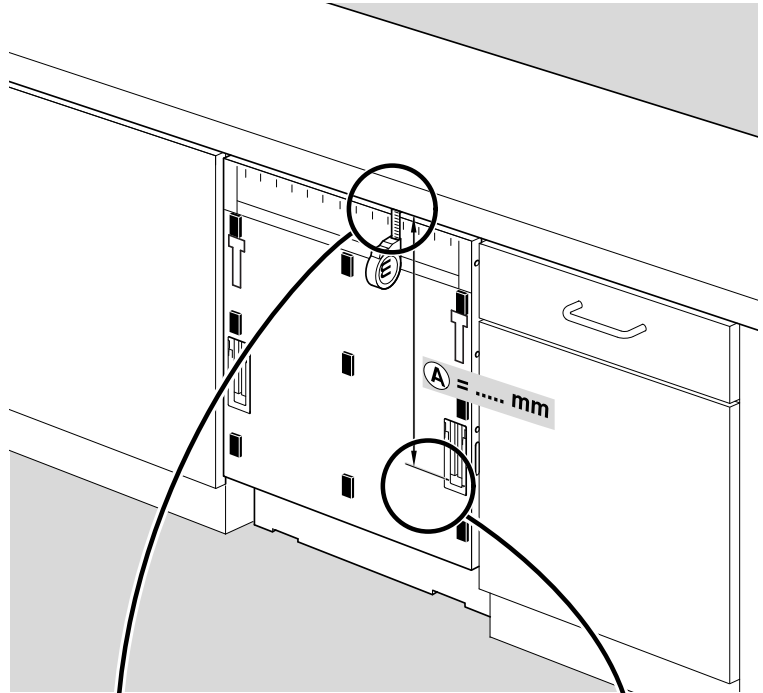
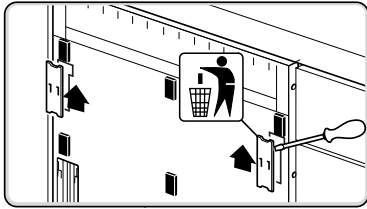

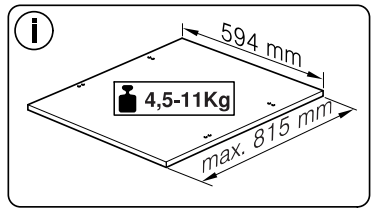
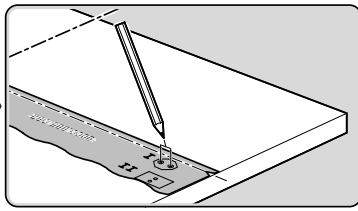
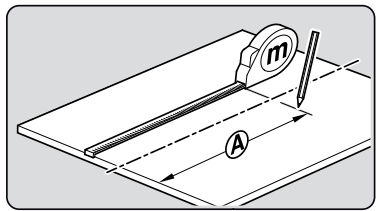
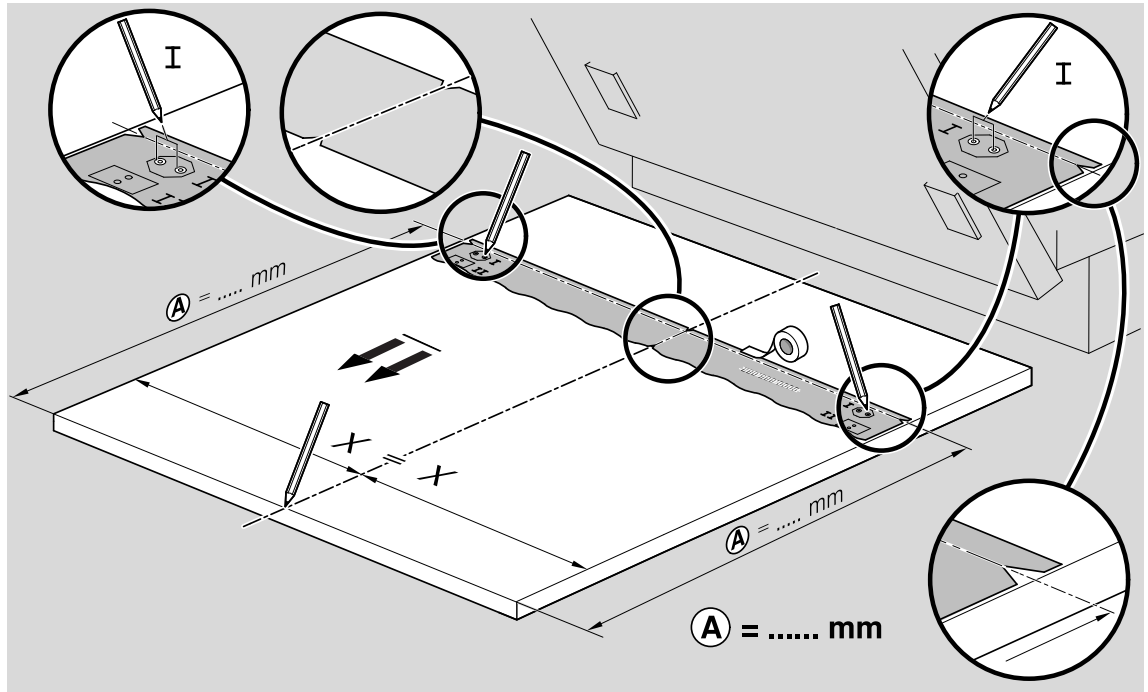
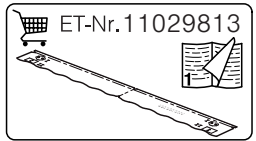

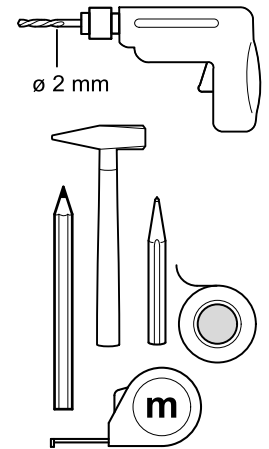
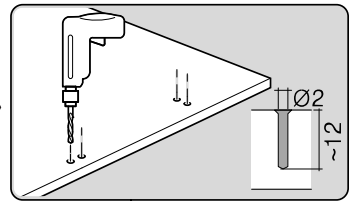
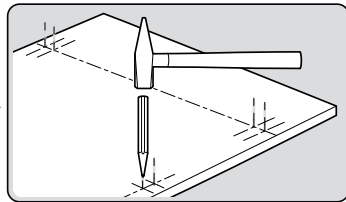
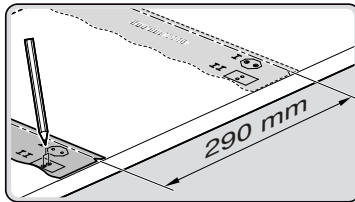
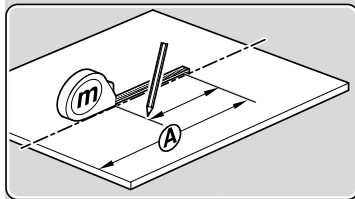
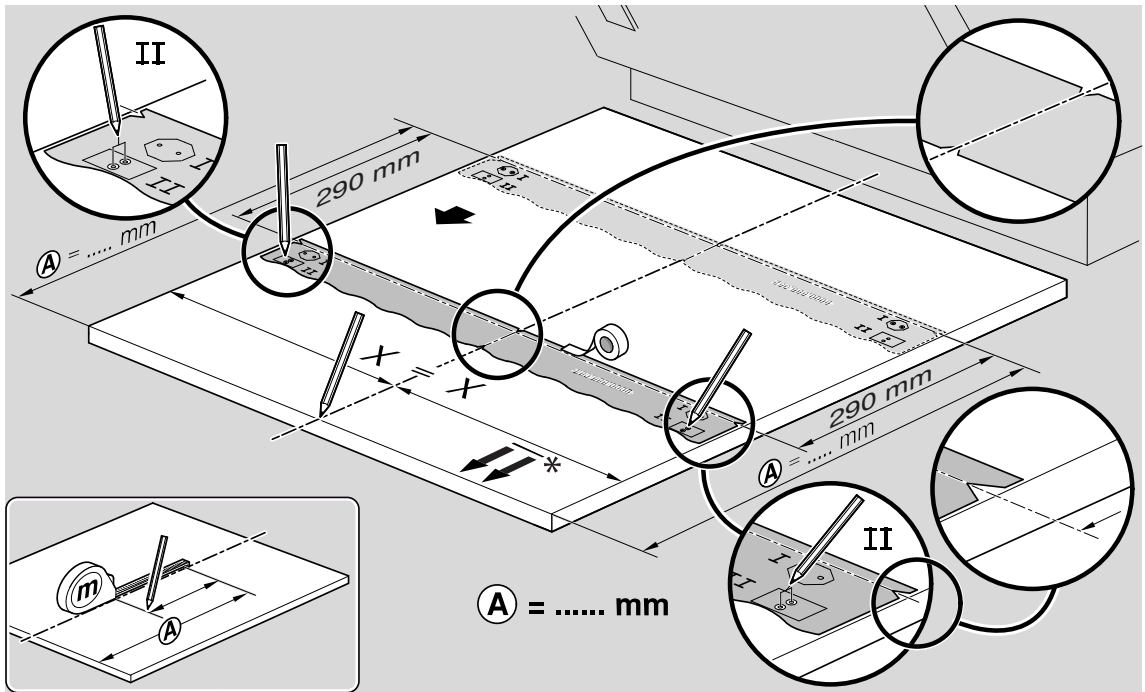
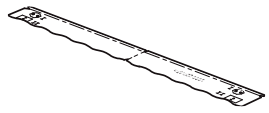

Ø4X15



Torx
T 20



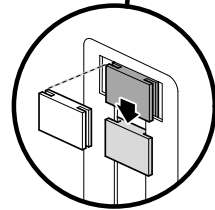
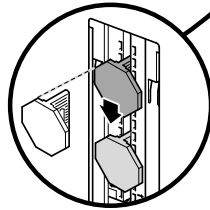
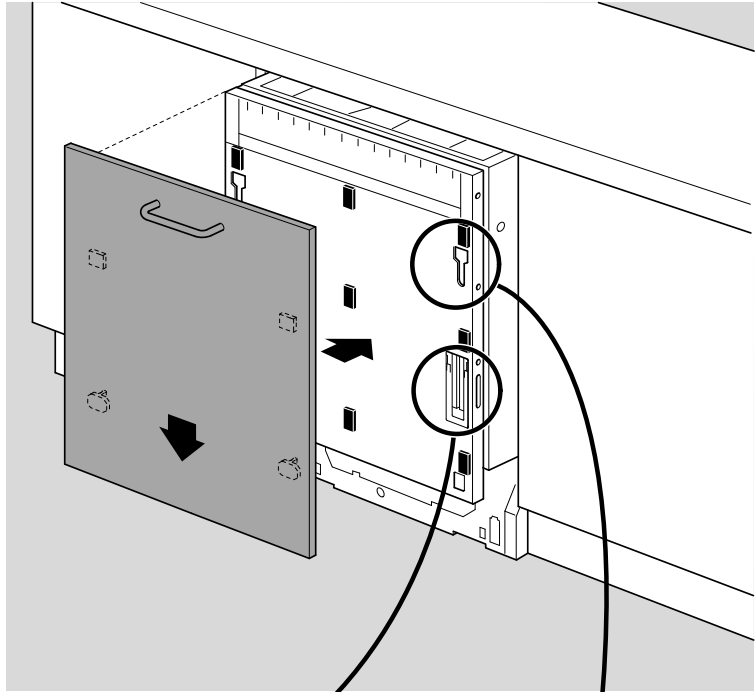
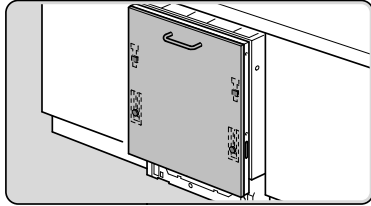
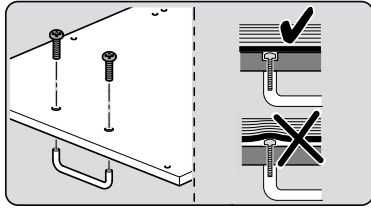

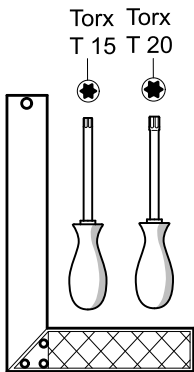
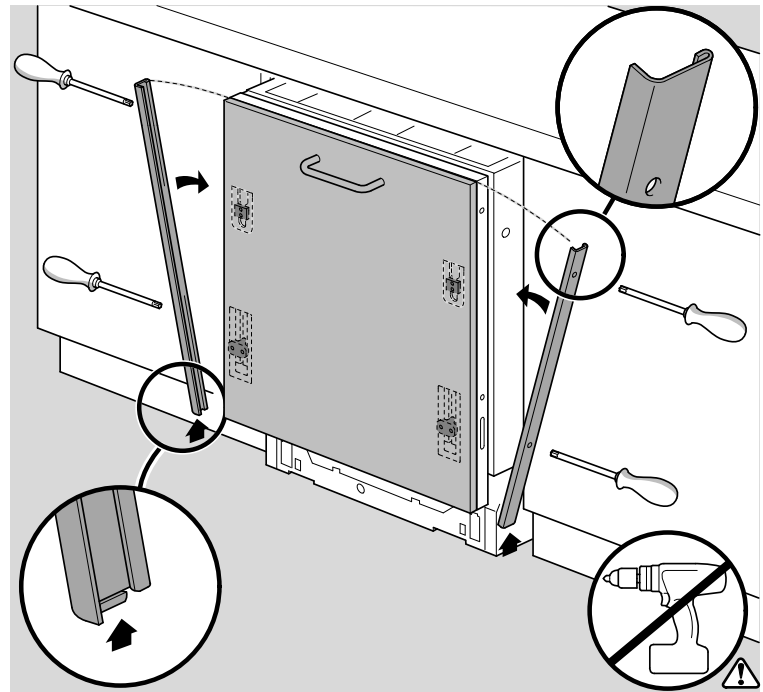
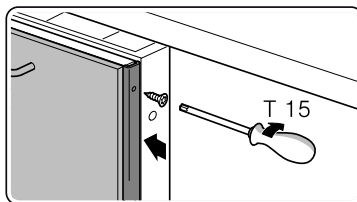
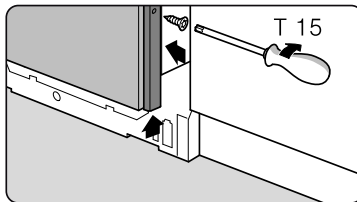
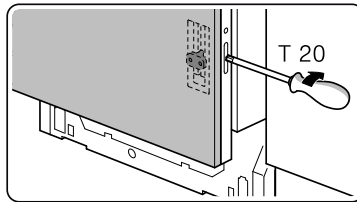
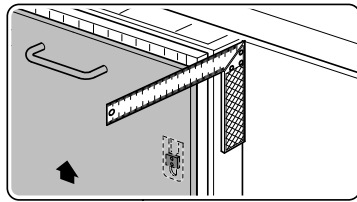

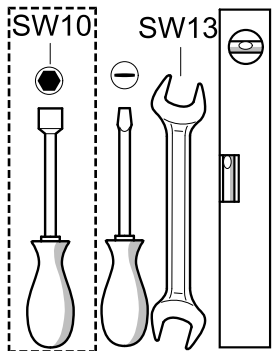
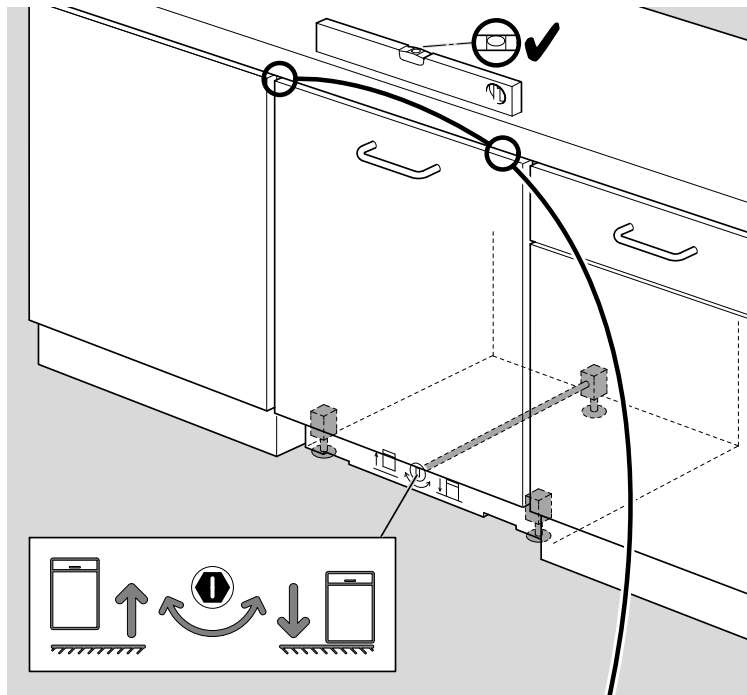
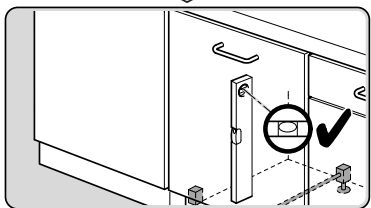
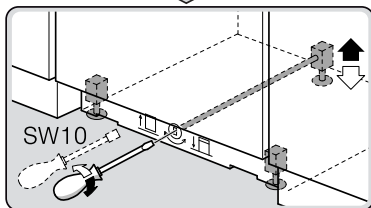
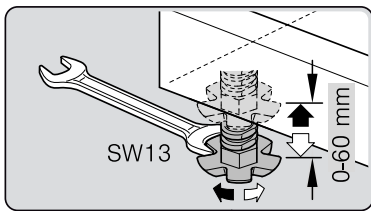

verspannen
brace
calar verticalement
Enrasar

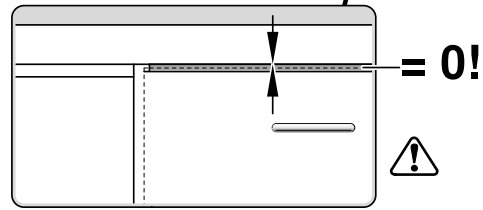

Ø4X30



Torx
T 20

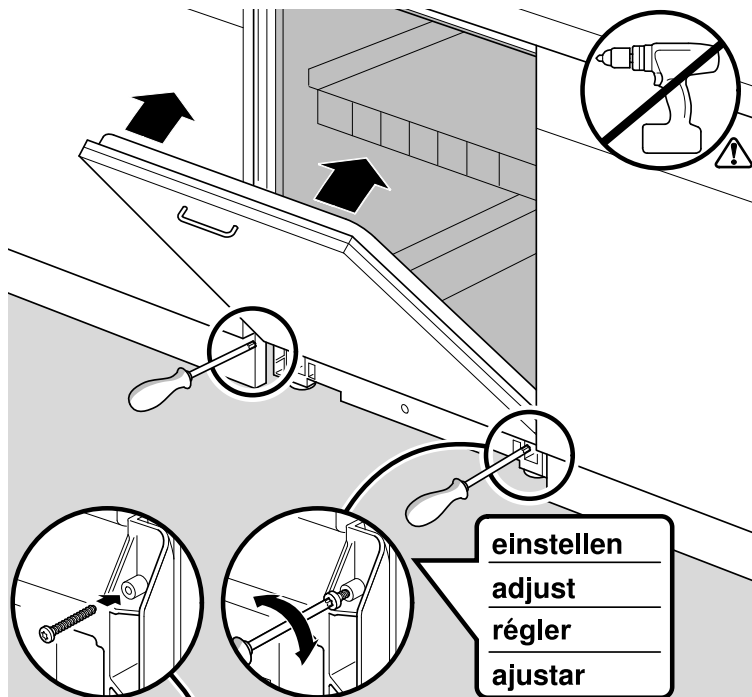
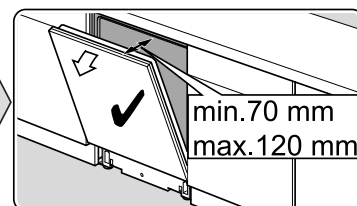
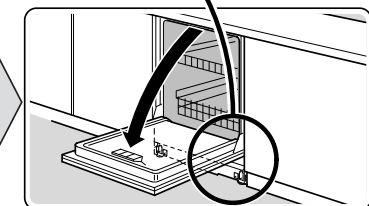
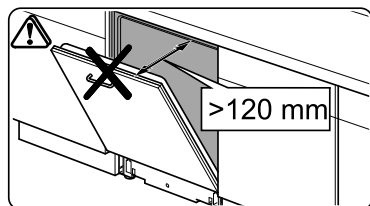
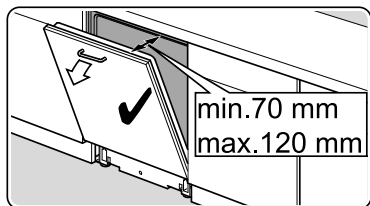

Ø4X36

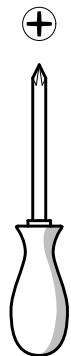
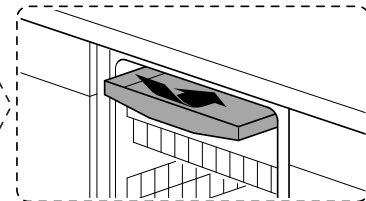
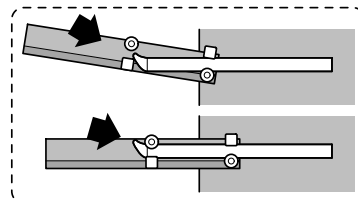
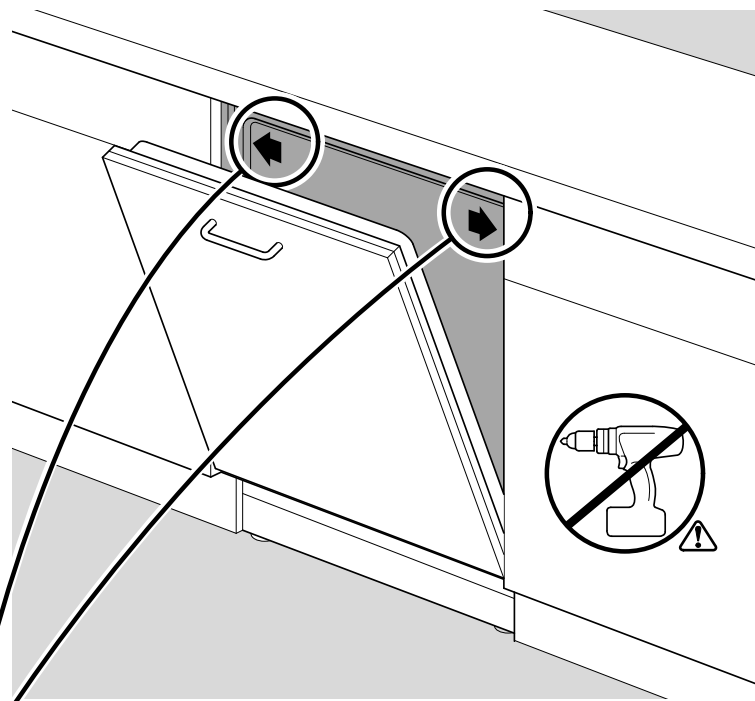
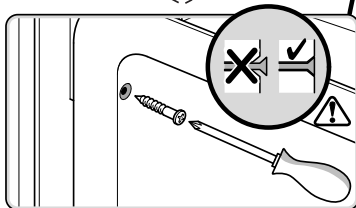
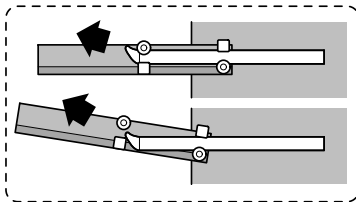
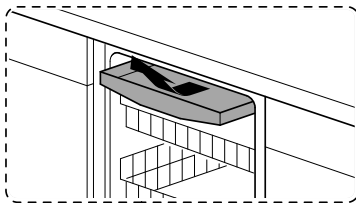
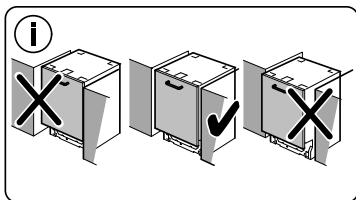
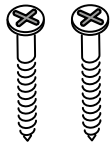

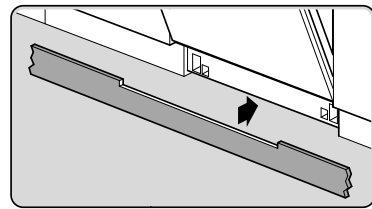
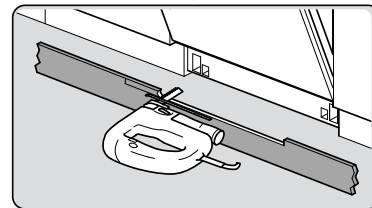
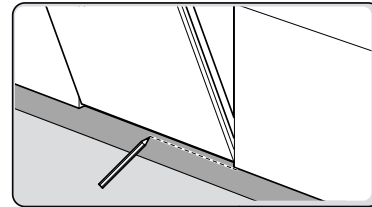
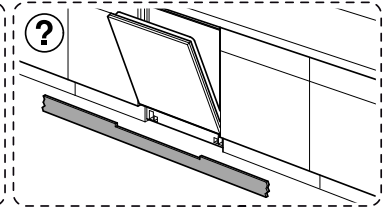
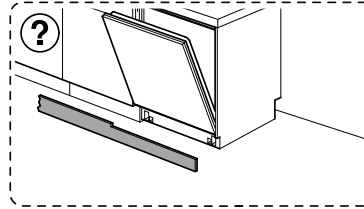
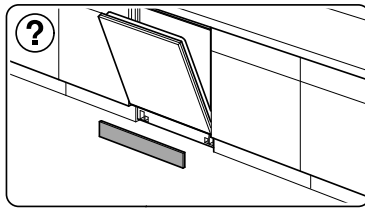
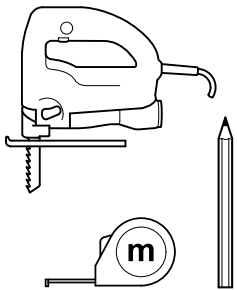

Ø4X15

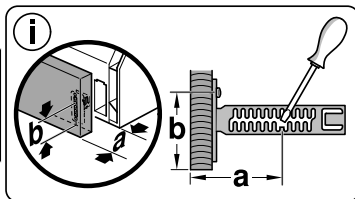
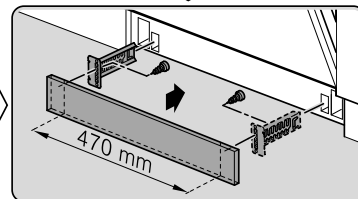
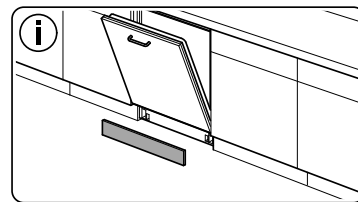
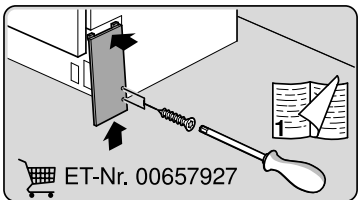
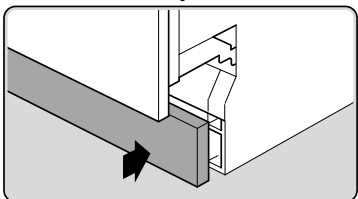
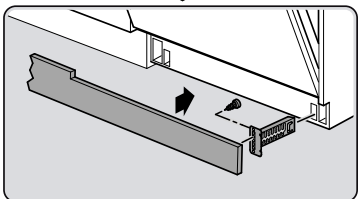
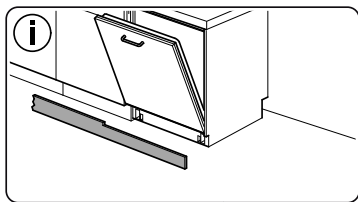
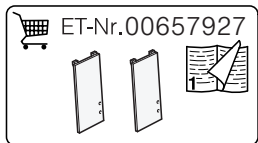
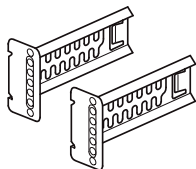

Torx
T 20

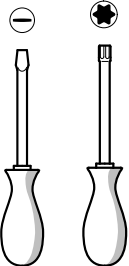

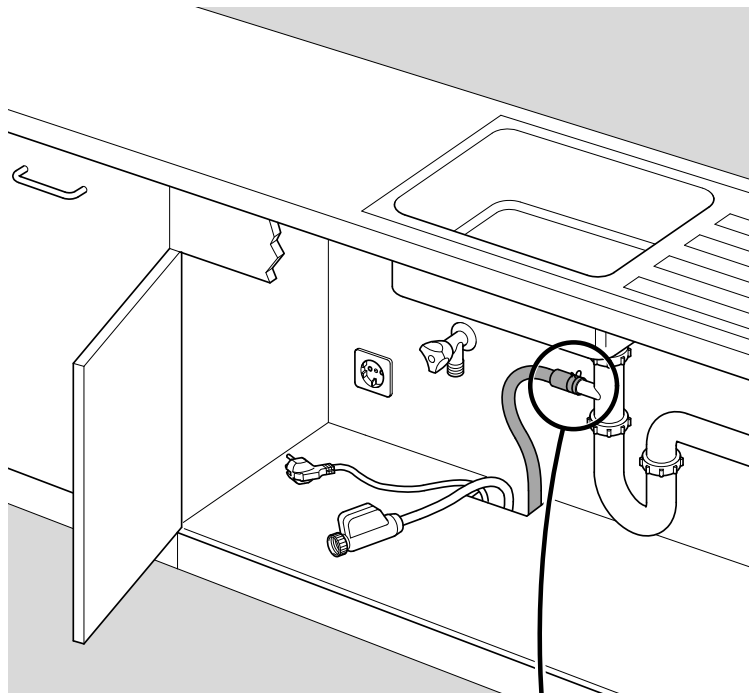
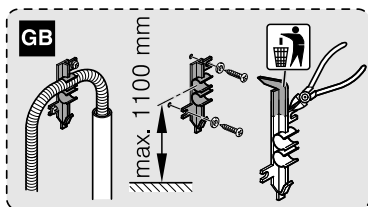
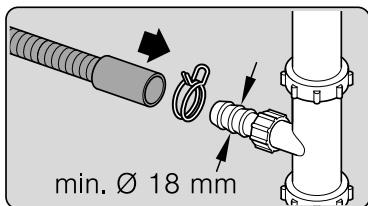
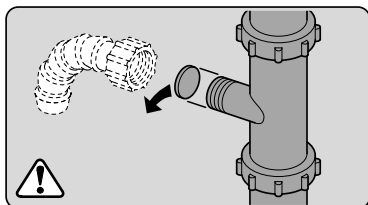
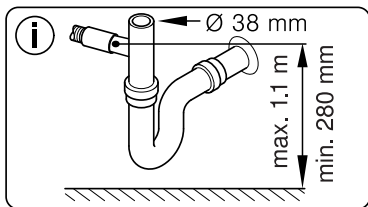
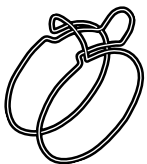

Dichtheit prüfen
Check for leaks
Verifiez l'étanchéité
Verificar la estanqueidad

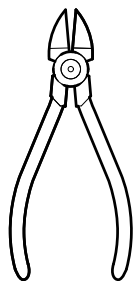
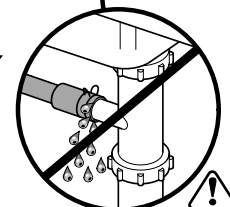

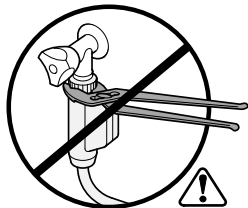
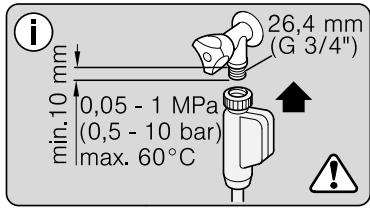

max. 10 Nm

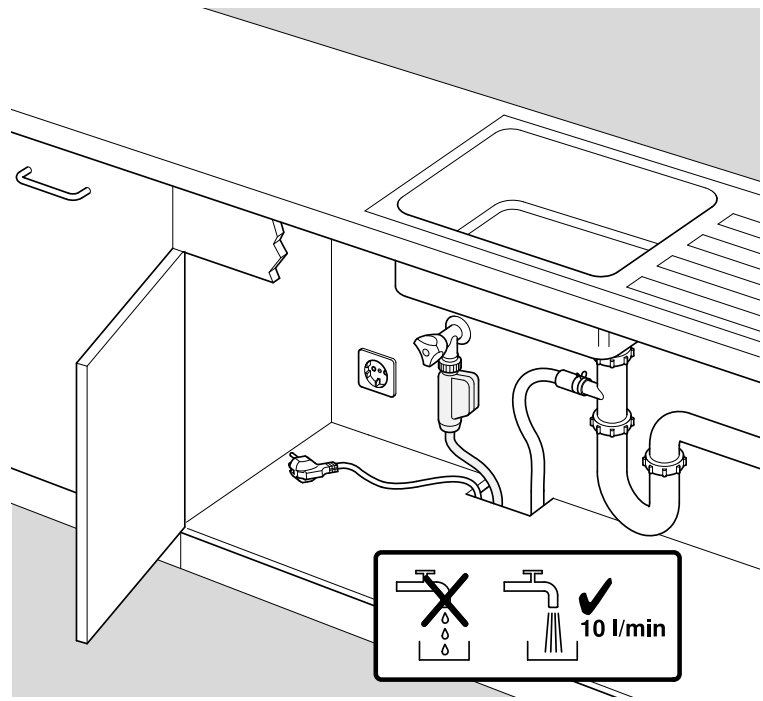

Dichtheit prüfen
Check for leaks
Verifiez l'étanchéité
Verificar la estanqueidad



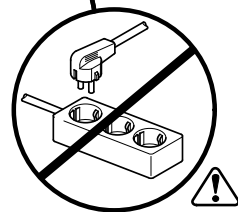
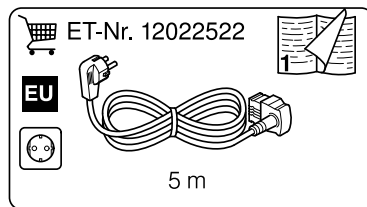
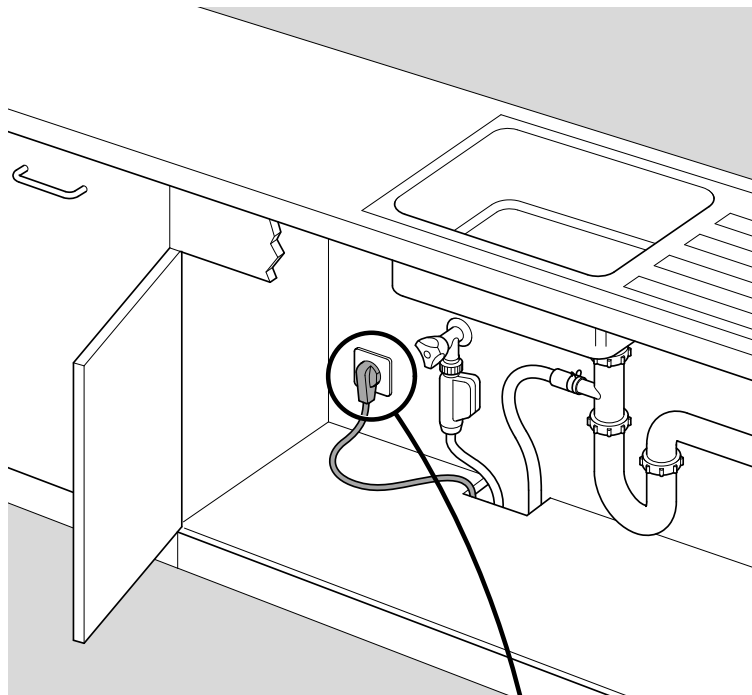
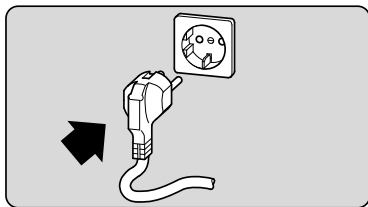



A series of horizontal lines for writing, starting from the top and extending to the bottom of the page, with a vertical margin line on the left side.