

Crystal Černé sklo | 106.0374.283

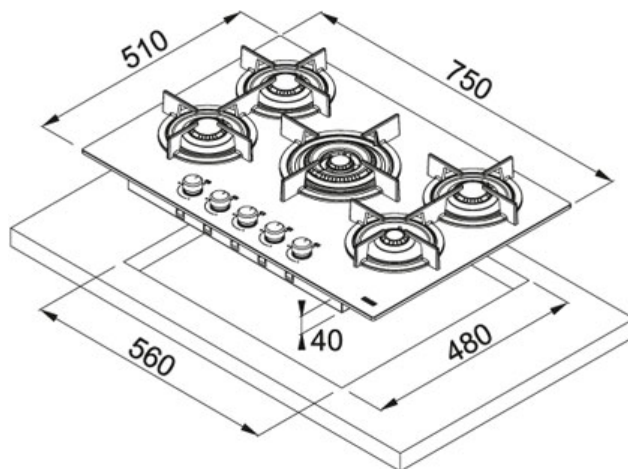





FAMILY : Varné desky | SERIE : Crystal | MODEL : FHCR 755 4G TC HE BK C | FINISH : Černé sklo | PRODUCT LINE : Crystal | INSTALLATION TYPE : Vestavné plynové varné desky



TECHNICKÉ ÚDAJE

Výřez	480.00 mm
Šířka v cm	60.00 cm
Výřez	560.00 mm
Rošt	Litinový
Rozměr	510.00 mm
Výkon (W)	<1000W 2X2000W 1750W 4000W
Šířka	750.00 mm
Hloubka výřezu	40.00 mm
Bezpečnostní pojistka	Ano
Spodní skříňka	600.00 mm

CHARAKTERISTIKA

	Zabudované elektrické zapalování		Litinový rošt
			Termoelektrická pojistka zhasnutí plamene
	Trojkorunka		Šíře 75 cm
	Hořáky 5		